

Data Sheet



Article number: 51503383130010

Description: Vibration damper GP-1I 80x63
M12, NR shore 57

Measures

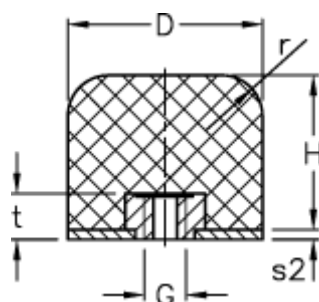

D	= 80	t = 12
d2	= 3	
G	= M12	
H	= 63	
Load capacity F (kN)	= 60.0	
Load capacity f (mm)	= 35	
Load capacity W (J)	= 560	
r	= 18.0	